

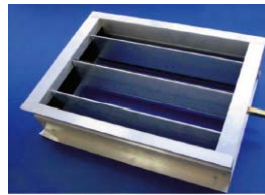

# *Rejillas y difusores*

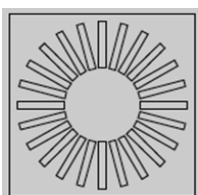

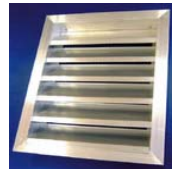
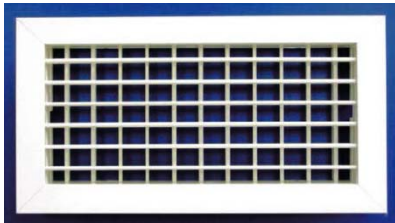

<b>MM</b>	<b>100</b>	<b>150</b>	<b>200</b>	<b>250</b>	<b>300</b>	<b>350</b>	<b>400</b>
<b>PVP</b>	0,79	0,85	0,94	0,98	1,06	1,17	1,28
<b>MM</b>	<b>450</b>	<b>500</b>	<b>600</b>	<b>700</b>	<b>800</b>	<b>900</b>	<b>1000</b>
<b>PVP</b>	1,39	1,53	1,81	2,09	2,44	2,78	3,16

**Marco de montaje, MM**

Fabricados en chapa de acero galvanizado, el hueco a practicar en el paramento será el de las medidas nominales.  
 Se suministra siempre como largueros independientes.  
 Admite clip de montaje y fijación oculta para la fijación de las rejillas.  
 Su montaje es incompatible con el portafiltras PF.

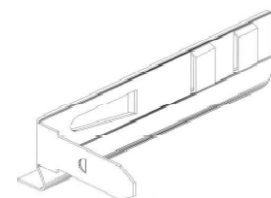

**HS Rejilla de impulsión aletas móviles simple deflexión**

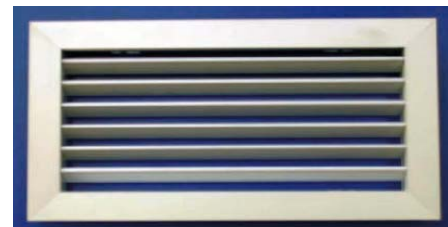
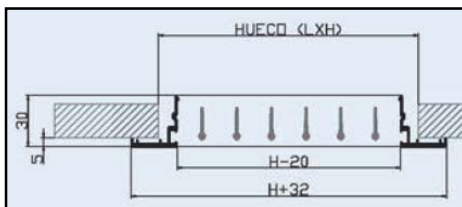

<b>HS</b>		<b>200</b>	<b>250</b>	<b>300</b>	<b>350</b>	<b>400</b>	<b>450</b>	<b>500</b>	<b>600</b>	<b>700</b>	<b>800</b>	<b>900</b>	<b>1000</b>
<b>H: altura</b>	<b>100</b>	11,84	13,26	14,69	16,25	17,61	18,94	20,22	23,11	25,92	31,64	33,63	37,90
	<b>150</b>	12,90	14,72	16,59	18,40	20,24	21,76	23,63	26,65	29,30	35,61	38,79	41,96
	<b>200</b>	14,10	16,04	18,40	21,32	22,75	24,64	26,80	29,81	33,17	39,46	42,45	46,13
	<b>250</b>	18,80	18,70	20,55	23,28	25,65	27,65	29,93	33,78	37,40	44,61	50,12	54,44
	<b>300</b>	20,74	23,06	23,48	26,09	28,51	30,83	32,81	36,64	42,45	52,42	57,36	62,86
	<b>350</b>	22,73	25,92	27,93	29,19	32,90	36,47	39,80	46,26	52,24	64,65	71,21	77,95
	<b>400</b>	24,60	27,41	30,18	35,25	39,73	44,84	50,27	58,13	66,04	73,99	82,00	90,20
	<b>450</b>	26,53	29,64	32,65	38,59	46,95	48,48	56,37	64,99	74,53	85,43	92,95	110,48
	<b>500</b>	28,47	31,83	35,25	39,01	52,26	57,67	62,46	71,92	82,99	96,91	103,92	114,05
	<b>600</b>	35,03	38,02	41,34	49,12	60,98	67,09	73,22	86,34	103,33	111,35	118,73	129,63
<b>700</b>	43,53	47,78	52,33	61,44	67,61	72,71	77,84	87,65	108,94	119,79	133,54	145,20	
<b>800</b>	48,21	53,72	58,94	68,01	74,42	79,95	85,46	111,48	124,50	128,23	148,36	160,63	
<b>900</b>	52,98	59,49	65,68	75,33	81,38	87,06	92,72	118,59	131,51	162,27	163,16	176,07	
<b>1000</b>	57,63	65,35	72,59	82,08	89,01	94,87	100,73	127,16	153,63	176,85	191,63	213,77	

Precio en anodizado y lacado color blanco

Consultar en nuestra página web WWW.HOSCLIMA.COM rejillas con regulación de caudal

**HDD Rejilla de impulsión lamas móviles doble deflexión**

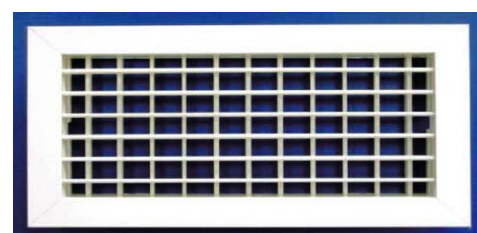
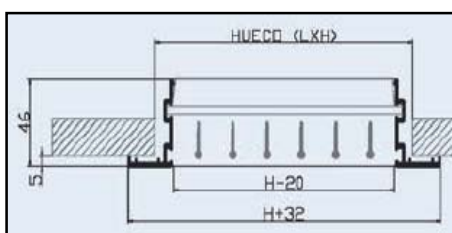

<b>HDD</b>		<b>L : longitud</b>											
		<b>200</b>	<b>250</b>	<b>300</b>	<b>350</b>	<b>400</b>	<b>450</b>	<b>500</b>	<b>600</b>	<b>700</b>	<b>800</b>	<b>900</b>	<b>1000</b>
<b>H: altura</b>	<b>100</b>	16,04	18,29	20,58	22,82	25,18	27,48	29,17	33,09	40,89	44,44	47,85	51,72
	<b>150</b>	18,81	21,46	24,06	26,86	29,49	32,21	35,21	40,05	49,41	55,51	58,23	66,33
	<b>200</b>	21,47	24,17	27,67	30,83	33,74	36,62	39,76	46,72	58,72	65,75	73,18	80,79
	<b>250</b>		28,24	31,31	34,60	37,84	40,93	43,89	52,93	67,50	76,53	85,04	93,85
	<b>300</b>			34,74	38,23	41,39	45,13	48,34	59,26	76,36	86,27	96,36	107,41
	<b>350</b>				43,19	46,95	50,69	55,83	68,40	88,02	100,95	112,85	125,71
	<b>400</b>					56,50	61,00	67,36	82,32	96,33	109,97	124,62	137,88
	<b>450</b>						69,20	73,19	89,52	104,68	120,01	134,97	150,17
	<b>500</b>							78,98	96,62	113,05	130,14	145,30	162,44
	<b>600</b>								104,01	139,70	149,09	162,62	205,31
<b>700</b>									158,77	204,21	242,55	280,85	
<b>800</b>										216,26	254,58	296,19	
<b>900</b>											270,99	323,57	
<b>1000</b>												349,85	

Precio en anodizado y lacado color blanco

**HDDR Rejilla de impulsión aletas móviles doble deflexión con regulación**

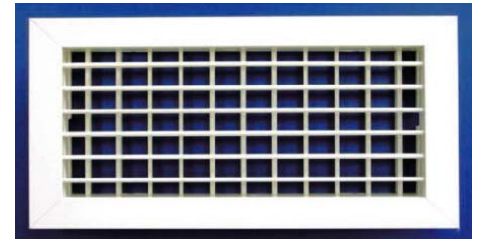
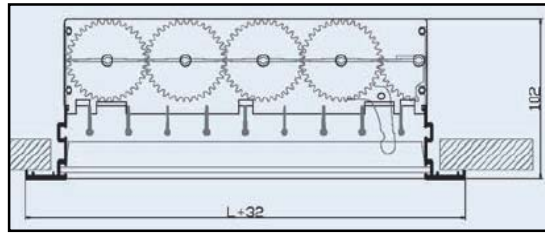

HDDR		L : longitud											
		200	250	300	350	400	450	500	600	700	800	900	1000
H: altura	100	26,36	29,46	32,87	35,93	39,41	42,56	45,37	41,21	67,13	72,92	78,02	84,12
	150	29,71	33,47	37,20	41,10	44,84	48,94	53,06	48,57	77,88	86,20	91,69	102,04
	200	33,21	37,28	41,62	46,46	50,45	54,74	59,29	55,26	89,99	99,21	109,46	119,83
	250		42,87	47,44	52,15	56,90	61,44	66,18	62,96	102,63	114,62	126,06	138,41
	300			52,04	57,29	62,19	67,69	72,38	69,92	114,44	127,88	141,46	155,49
	350				63,70	69,51	74,72	81,92	79,13	129,02	146,07	160,92	177,90
	400					80,54	87,08	95,49	92,11	140,31	158,07	176,80	194,18
	450						97,34	103,68	99,77	151,61	170,82	191,26	211,13
	500						111,21	107,30	162,94	183,68	204,56	226,94	

Precio en anodizado y lacado color blanco

TABLA DE SELECCIÓN DE CAUDALES REJILLAS IMPULSION									
Caudal aire m³/h.	Dimensiones Nominales	Δp m/m ca	Alcance m.l.	db(A)	Caudal aire m³/h.	Dimensiones nominales	Δp m/m ca	Alcance m.l.	db(A)
200	200 x 100	1,2	4,9	20	900	700 x 100	2	11,8	32
250	200 x 100	1,9	6,2	26		450 x 150			
315	250 x 100	1,9	6,9	27		350 x 200			
355	300 x 100	1,7	7,2	27	1000	800 x 100	1,9	12,3	32
400	300 x 100	2,2	8,1	30		500 x 150			
	200 x 150								
450	350 x 100	2	8,3	29	1120	900 x 100	1,9	13	32
500	400 x 100	1,8	8,6	28		600 x 150			
	250 x 150								
560	200 x 200	1,8	9,2	29	1250	450 x 200	1,9	13,7	33
	450 x 100								
300 x 150									
630	500 x 100	1,9	9,7	30	1400	800 x 150	1,6	14	32
	350 x 150								
	250 x 200								
710	500 x 100	2,4	11	32	1600	900 x 150	1,6	15	33
	350 x 150								
	250 x 200								
800	500 x 100	2,1	11,3	32	1800	1000 x 150	1,5	15,7	32
	600 x 100								
	400 x 150								
300 x 200									



**FH Rejilla retorno aletas  
fijas 45°**

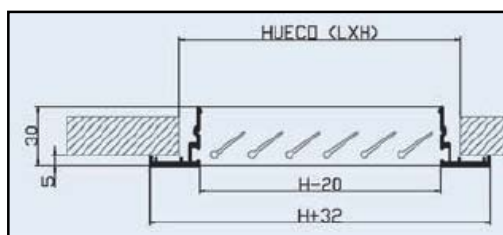

FH		200	250	300	350	400	450	500	600	700	800	900	1000
H: altura	100	12,46	13,64	14,97	16,57	18,03	19,45	20,95	23,83	26,69	29,55	31,71	39,08
	150	13,55	15,49	17,28	19,07	20,95	22,97	24,13	28,16	31,96	35,51	42,14	47,63
	200	14,93	17,06	19,40	21,62	23,86	26,01	28,31	32,90	37,42	41,72	46,37	56,01
	250	18,80	18,81	21,69	24,56	27,26	29,86	32,70	42,14	47,72	53,46	59,19	65,17
	300	20,84	23,06	24,24	27,58	30,80	34,11	37,83	47,83	54,53	61,17	67,67	74,39
	350	22,73	25,33	28,02	31,83	35,86	39,83	44,16	56,32	64,32	72,30	80,77	88,71
	400	24,60	27,41	30,18	35,25	38,68	44,31	48,54	62,90	71,69	81,59	89,94	98,94
	450	26,53	29,64	32,65	38,59	46,95	52,07	56,61	69,91	79,68	90,36	100,24	110,33
	500	28,47	31,83	35,25	39,01	52,26	57,67	64,69	76,13	87,66	99,16	110,53	121,72
	600	35,03	38,02	41,34	49,12	61,15	67,09	73,22	88,10	101,37	116,07	129,12	144,03
	700	40,82	47,78	52,33	61,44	67,61	72,71	77,84	97,64	117,44	133,58	149,55	165,91
	800	48,21	53,72	58,94	68,01	74,42	79,95	85,46	111,48	124,50	151,13	169,92	188,39
900	52,98	59,49	65,68	75,33	81,38	87,06	92,72	118,59	131,51	162,27	190,59	211,16	
1000	57,63	65,45	72,59	82,08	89,01	94,87	100,73	127,16	153,63	176,85	191,63	234,60	

Precio en anodizado y lacado color blanco

Consultar en nuestra página web WWW.HOSCLIMA.COM rejillas con regulación de caudal

Caudal	Dimensiones	$\Delta p$	db(A)	Caudal	Dimensiones	$\Delta p$	db(A)
aire m <sup>3</sup> /h.	nominales mm	m/m c.a.		aire m <sup>3</sup> /h.	nominales mm	m/m c.a.	
200	250 x 100	2,1	28	900	800 x 150	1,9	33
250	300 x 100	2,4	31		600 x 200		
	200x 150						
315	350 x 100	2,7	33	1000	900 x 150	1,8	34
355	400 x 100	2,6	33		700 x 200		
	250 x 150						
400	450 x 100	2,7	34	1120	1000 x 150	1,7	33
	300 x 150						
500	600 x 100	2,3	33		600 x 250		
	400 x 150						
	300 x 200						
630	700 x 100	2,1	33	1250	900 x 200	1,6	33
	450 x 150						
	350 x 200						
710	900 x 100	2,1	34	1400	1000 x 200	1,6	34
	600 x 150						
	450 x 200						
800	1000 x 100	2,2	34	1600	1000 x 250	1,4	33
	700 x 150						
	500 x 200						
				1800	900 x 300	1,4	33
					800 x 350		
					700 x 400		

**LCH: 1 SENTIDO LCH2: 2 SENTIDOS**  
**Rejilla lama curva lama movil impulsión**

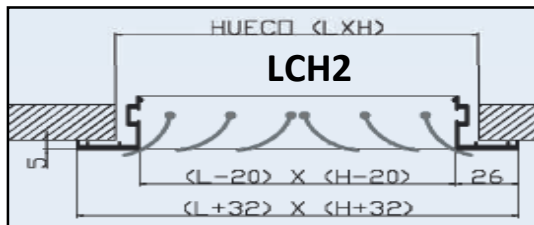
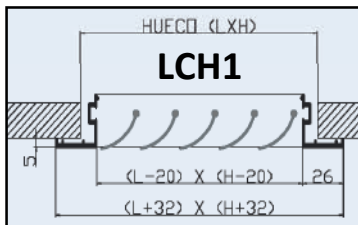

LCH		200	250	300	350	400	450	500	600	700	800	900	1000
H: altura	100	15,74	17,47	17,81	18,69	19,54	20,38	21,83	30,91	39,32	40,70	43,09	45,62
	150	17,68	19,21	20,60	21,88	23,15	24,43	26,36	37,31	45,52	47,38	50,55	53,75
	200	19,71	21,44	23,39	24,96	26,85	28,75	30,91	43,66	51,56	54,08	58,09	62,21
	250	23,77	25,99	26,63	28,36	30,43	32,32	34,60	47,09	58,28	61,37	66,38	70,82
	300	28,51	29,26	29,74	30,18	30,95	32,76	35,40	47,61	61,02	64,66	69,76	79,67
	350	31,24	33,01	34,30	39,92	45,23	47,82	50,73	66,63	74,63	79,55	85,43	92,33
	400	33,57	36,56	40,27	44,31	49,52	52,37	56,10	72,64	81,42	86,74	93,70	100,55
	450	36,63	40,20	43,58	49,12	52,67	56,05	61,30	79,75	89,12	95,24	102,42	110,13
	500	39,44	43,14	46,91	53,65	56,96	58,46	64,92	86,82	96,81	103,79	111,16	119,68
	600	51,57	58,53	66,43	76,89	86,11	91,70	98,37					
700	57,03	66,04	70,67	85,44	97,35	104,28	111,16						
800	63,30	71,97	82,65	91,26	105,18	112,48	119,77						
900	73,25	80,18	87,17	98,51	112,79	122,14	131,51						
1000	78,93	85,65	93,75	107,34	122,41	135,22	148,04						

Precio en anodizado y lacado color blanco

Consultar en nuestra página web WWW.HOSCLIMA.COM rejillas con regulación de caudal

**LB Y LB2 Rejilla lineal**



LB		L : longitud												Suplemento tramo abatible	
		200	250	300	350	400	450	500	600	700	800	900	1000	2000	
H: altura	50	14,54	15,12	15,49	15,79	16,18	16,36	16,79	18,63	20,31	22,26	24,14	26,82	61,64	15,20
	75	16,39	17,02	17,60	18,16	18,87	19,22	19,72	22,57	25,40	28,16	31,06	33,90	77,97	
	100	18,15	18,87	19,80	20,52	21,46	22,01	23,06	27,11	30,90	34,83	38,64	42,63	98,07	
	125	19,75	21,14	22,57	23,94	25,37	26,67	28,03	32,43	36,75	41,30	45,64	49,96	114,85	
	150	21,32	23,36	25,36	27,30	29,24	31,27	33,01	37,75	42,60	47,75	52,62	57,26	131,69	
	200	24,64	27,80	30,97	33,82	37,10	39,62	42,65	48,81	54,74	60,90	66,85	73,00	167,97	25,30
250		33,86	37,90	41,80	45,89	49,47	52,98	60,58	69,18	77,31	85,42	93,45	214,93		
300			42,71	47,15	51,93	56,37	60,58	70,71	80,17	89,78	99,28	108,98	250,69		

Precio en anodizado y lacado color blanco

Consultar en nuestra página web WWW.HOSCLIMA.COM rejillas con regulación de caudal



LS Rejilla lineal de suelo

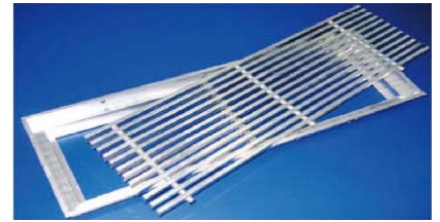
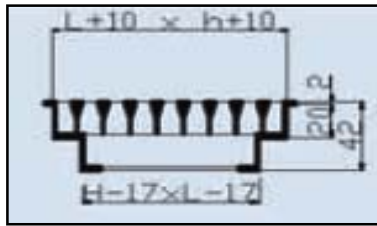

LS		L : longitud											
		200	250	300	350	400	450	500	600	700	800	900	1000
H: altura	100	34,09	37,36	40,68	43,99	47,27	50,59	53,88	60,49	67,10	73,69	80,29	86,90
	150	38,64	43,01	47,38	51,75	56,13	60,50	64,90	73,63	82,41	91,14	99,89	108,64
	200	43,29	48,85	54,44	60,00	65,57	71,14	76,71	87,87	99,00	110,14	121,29	132,44
	250		53,69	60,29	66,94	73,55	80,17	86,81	100,04	113,28	126,53	139,77	153,03
	300			74,67	81,89	89,05	96,26	103,43	117,82	132,19	146,56	160,97	175,34

Precio en aluminio crudo

RP Rejilla de puerta con contramarco



RP		L : longitud											
		200	250	300	350	400	450	500	600	700	800	900	1000
H: altura	100	22,78	24,56	26,67	28,98	31,50	33,34	36,00	40,67	45,17	50,22	54,63	59,40
	150	26,34	29,35	32,33	35,35	38,17	41,40	43,93	50,38	56,45	62,57	70,74	75,14
	200	31,02	34,41	38,08	41,62	45,16	48,85	52,49	59,85	67,75	75,40	82,52	90,27
	250		35,76	45,64	49,96	54,02	58,36	62,37	70,88	87,39	87,39	97,08	105,59
	300			56,01	60,69	66,00	70,85	75,78	85,47	95,88	105,87	115,53	126,39
	350				72,93	76,31	84,26	92,33	102,93	113,97	124,68	135,81	147,65
	400					83,43	94,43	105,47	116,34	127,45	139,07	149,39	163,03
	450						100,80	112,01	126,15	139,89	154,09	168,12	183,99
	500							118,55	135,94	152,31	169,12	186,86	204,94
	600								153,95	176,88	200,66	225,16	250,05
700									203,63	223,10	242,49	273,72	
800										238,53	271,13	293,21	
900											292,33	328,09	
1000												363,87	

Precio en anodizado y lacado color blanco

RTM Rejilla para techo modular

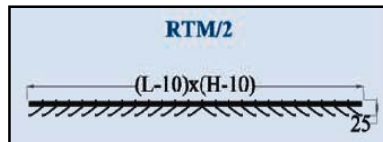
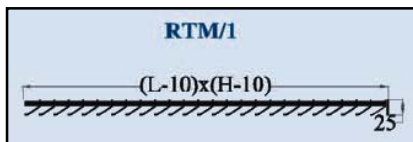

RTM 1 SENTIDO		
RTM		L : longitud
		600
H: altura	300	38,75
	600	67,07

RTM/2 2 SENTIDOS		
RTM		L : longitud
		600
H: altura	600	67,07

RTM-PF 1 SENTIDO CON FILTRO RTM/2-PF 2 SENTIDOS CON FILTRO		
RTM		L : longitud
		600
H: altura	300	70,57
	600	121,59

## RR Rejilla retorno reticula

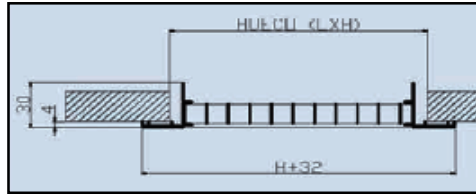

RR		L : longitud											
		200	250	300	350	400	450	500	600	700	800	900	1000
H: altura	100	13,40	15,05	16,91	18,70	20,48	22,22	24,01	27,03	29,93	32,90	35,89	38,84
	150	14,93	16,79	18,91	20,95	22,97	24,94	26,90	30,86	34,89	38,79	42,96	46,83
	200	16,40	18,69	20,93	23,47	25,40	27,96	30,21	35,85	39,97	45,26	53,72	55,21
	250		20,42	23,50	26,67	29,68	32,98	36,13	41,85	47,49	53,44	58,27	64,51
	300			26,02	29,97	33,94	38,02	41,73	48,23	51,05	61,11	67,72	74,32
	350				35,27	40,09	45,12	50,33	53,60	64,48	71,50	78,35	85,11
	400					44,75	51,39	57,85	64,72	71,76	78,39	85,07	91,95
	450						55,30	61,84	70,55	79,26	87,80	96,36	104,54
	500							65,79	76,39	86,74	97,20	107,65	118,27
	600								86,74	99,42	107,65	120,56	133,97

Precio en anodizado y lacado color blanco

Consultar en nuestra página web WWW.HOSCLIMA.COM rejillas con regulación de caudal

## TAE Rejilla para toma de aire exterior

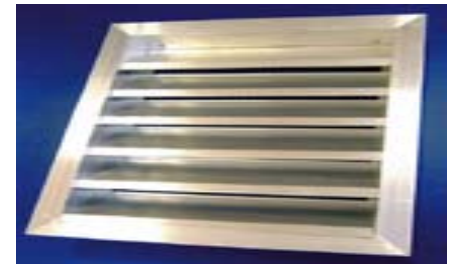
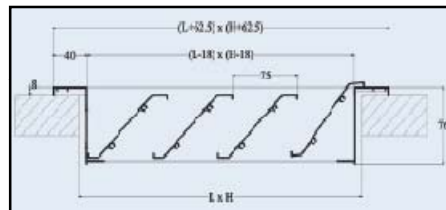

Acabado: aluminio sin tratar

TAE		L : longitud																
		400	500	600	700	800	900	1000	1100	1200	1300	1400	1500	1600	1700	1800	1900	2000
H: altura	325	66,64	73,18	79,72	86,27	92,81	99,35	105,89	112,45	119,00	125,54	132,09	138,63	145,17	151,71	158,26	164,80	171,34
	400	76,03	81,63	93,10	99,14	105,08	119,29	122,74	128,81	139,96	145,76	151,91	163,59	169,56	175,06	186,39	194,37	195,68
	475	85,30	92,00	104,65	113,20	118,97	131,88	139,02	146,44	159,14	165,87	172,50	185,64	193,16	204,74	212,60	219,67	228,07
	550	100,54	109,14	117,72	126,31	134,89	148,57	157,18	165,76	179,48	188,06	196,65	210,21	218,92	227,52	230,44	249,83	258,44
	625	110,09	119,84	129,60	139,28	149,04	163,82	173,50	183,22	197,71	207,72	217,43	232,22	241,93	251,62	255,70	276,15	285,86
	700	118,24	129,03	139,88	150,69	161,24	177,33	188,14	198,94	214,78	225,59	236,42	252,25	252,48	273,89	289,74	300,53	311,34
	775	130,03	142,14	154,31	166,45	178,58	195,75	207,92	220,04	237,24	249,40	261,52	278,73	290,85	303,01	308,15	332,34	344,48
	850	144,38	157,68	171,08	184,42	197,75	211,38	224,48	237,82	256,21	269,58	282,91	301,30	314,66	328,01	346,48	359,79	374,98
	925	158,48	168,20	182,75	197,30	211,86	226,42	240,99	255,57	275,18	289,75	304,28	323,93	338,46	353,02	372,68	387,21	401,64
	1000	162,92	178,68	194,44	210,25	252,78	241,78	257,51	273,29	294,14	317,93	325,68	346,51	362,25	378,05	398,85	414,65	430,40
	1075	173,54	190,50	207,49	224,48	241,44	258,44	275,40	292,40	314,44	331,43	375,17	370,58	387,43	404,39	426,45	443,44	460,42
	1150	189,05	206,91	224,74	242,54	260,38	278,22	301,01	318,85	336,67	354,51	372,26	390,15	407,96	425,79	453,53	471,38	489,26
	1225	202,21	221,58	239,69	260,45	279,80	299,20	323,70	343,11	362,50	381,90	401,33	420,68	440,09	459,50	489,08	508,46	527,88
	1300	211,48	229,79	254,33	273,29	293,95	314,51	340,23	360,86	381,47	402,04	422,82	443,25	463,90	484,51	515,26	535,88	556,50
	1375	220,25	242,09	263,90	285,69	307,52	329,88	356,77	378,88	396,39	422,24	444,06	465,90	487,69	509,54	541,42	563,33	587,81
	1450	230,58	257,64	282,11	306,38	328,07	351,61	386,55	401,81	424,59	446,45	472,80	494,36	510,17	542,03	570,14	593,18	616,19
	1525	242,54	270,80	295,04	319,30	356,97	368,30	400,28	421,82	446,08	470,33	495,64	519,90	544,14	568,39	597,70	621,95	646,19
	1600	253,39	281,27	306,74	332,21	357,68	383,61	414,14	439,59	465,05	490,50	517,00	542,49	567,95	593,40	623,96	649,40	674,85
	1675	265,08	291,75	318,43	345,07	371,74	398,38	430,67	457,31	483,97	510,70	538,37	565,04	591,75	618,30	650,18	676,81	703,50
	1750	279,41	307,32	335,18	363,09	390,99	419,34	452,27	480,14	506,66	535,92	564,86	596,25	617,82	648,50	681,46	709,35	737,20
1825	288,68	317,80	346,87	376,00	405,05	434,66	468,79	497,89	526,98	556,09	586,24	612,64	644,42	673,51	707,67	736,77	765,87	
1900	297,96	328,27	358,57	388,86	419,19	449,97	485,35	515,62	545,96	576,25	607,61	637,92	668,22	698,53	733,92	764,21	794,49	
1975	308,55	340,12	371,57	403,13	434,37	467,03	503,22	534,71	566,27	597,75	630,33	661,87	693,39	724,89	761,47	792,99	824,50	
2050	317,84	351,92	384,64	417,35	450,08	483,31	521,10	553,81	586,55	619,24	653,09	685,78	718,81	751,27	789,02	821,77	854,49	

**CRS Compuertas de regulación**

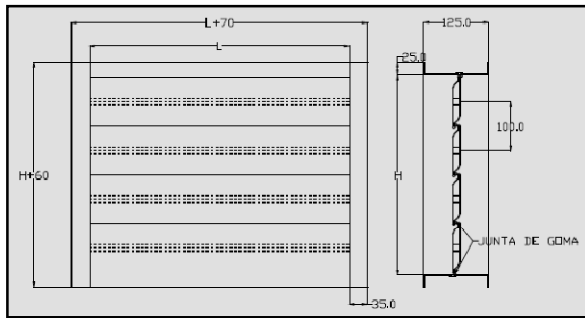

**Descripción:** Compuerta de regulación, fabricada en aluminio. Las lamas disponen de terminaciones elásticas para un correcto cierre.

**Acabados:** Aluminio crudo

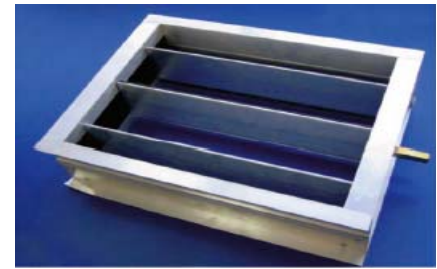

CRS		L : longitud														
		100	200	300	400	500	600	700	800	900	1.000	1.100	1.200	1.300	1.400	1.500
H: altura	110	103,44	115,93	128,52	141,04	153,63	166,02	178,48	190,99	203,51	216,12	240,43	252,90	265,39	277,89	290,40
	210	132,47	148,59	164,88	180,88	196,93	213,06	229,25	245,36	261,44	277,57	305,57	321,68	337,76	353,89	370,05
	310	161,52	181,20	201,01	220,71	240,43	260,20	279,91	299,74	319,42	339,13	370,78	390,55	410,14	429,92	449,64
	410	190,51	213,84	237,27	260,59	283,98	307,27	330,67	353,97	377,36	400,69	435,93	459,22	482,52	505,92	529,23
	510	219,59	246,46	273,50	300,51	327,43	354,41	381,34	408,31	435,24	462,26	500,96	527,99	554,97	581,89	608,88
	610	248,63	279,11	309,75	342,84	370,84	401,48	432,07	462,58	493,18	523,80	566,12	596,71	627,34	657,86	688,46
	710	277,65	311,87	346,01	380,22	414,43	448,62	482,72	516,93	545,53	585,40	631,29	665,51	699,73	733,96	768,04
	810	300,62	344,50	382,21	420,07	457,85	495,68	533,51	571,32	609,13	646,82	696,44	734,31	772,11	809,91	847,73
	910	335,73	377,18	418,58	459,88	501,42	542,72	584,12	625,54	666,96	708,43	761,63	803,09	844,49	885,89	927,27
	1.010	364,78	409,79	454,81	499,86	544,83	589,88	634,92	679,91	724,94	769,96	826,79	871,83	916,84	961,85	1.006,87
	1.110	405,54	454,26	502,89	551,50	600,12	648,72	697,29	746,12	794,70	843,34	891,96	940,58	989,19	1.037,95	1.086,54
	1.210	434,58	486,89	539,12	591,33	643,58	695,91	748,10	800,35	852,56	904,90	957,15	1.009,37	1.061,57	1.113,94	1.166,17
	1.310	463,59	519,54	575,34	631,18	687,08	742,96	798,78	856,64	910,54	966,48	1.022,28	1.078,12	1.134,07	1.189,89	1.245,71
	1.410	492,62	552,16	611,63	671,16	730,59	792,41	843,89	908,96	968,50	1.027,92	1.087,46	1.146,89	1.206,45	1.265,86	1.325,41
	1.510	521,80	584,86	647,82	710,99	774,00	837,13	900,19	963,31	1.026,46	1.089,49	1.152,64	1.215,69	1.278,80	1.341,83	1.405,29

**Accesorios compuertas de regulación**

			Tarifa actuadores (servomotores)	PVP
todo /nada	hasta 0,8 m <sup>2</sup>	dan 1	actuador t/n reversible, 24 V. A.c.	233,16
		dan 1,s	actuador t/n reversible, 24 V. A.c. Con dos contactos auxiliares (1,5 A)	285,67
		dan 2	actuador t/n reversible, 230 V. A.c.	245,33
		dan 2,s	actuador t/n reversible, 230 V. A.c. Con dos contactos auxiliares (1,5 A)	297,21
	hasta 1,5 m <sup>2</sup>	das 1	actuador t/n reversible, 24 V. A.c.	305,54
		das 1,s	actuador t/n reversible, 24 V. A.c. Con dos contactos auxiliares (1,5 A)	386,88
		das 2	actuador t/n reversible, 230 V. A.c.	319,63
		das 2,s	actuador t/n reversible, 230 V. A.c. Con dos contactos auxiliares (1,5 A)	389,78
	hasta 3 m <sup>2</sup>	da 1	actuador t/n reversible, 24 v. a.C./DC	338,52
		da 1,s	actuador t/n reversible, 24 V. A.c.7dc Con dos contactos auxiliares (1,5 A)	422,44
		da 2	actuador t/n reversible, 230 V. A.c.	351,34
		da 1,f	actuador T/N con muelle de retorno 24 V. Ac/dc	662,64
		da 1,f-s	actuador T/N con muelle de retorno 24 V. Ac/dc Con dos contactos auxiliares (1,5 A)	
		da 2,f	actuador T/N con muelle de retorno 230 V.	727,65
		da 2,f-s	actuador T/N con muelle de retorno 230 V Con dos contactos auxiliares (1,5 A)	779,85
proporcionales	hasta 0,8 m <sup>2</sup>	dmm 1,1	actuador proporcional 24 V. Ac, mando señales 0-10 Vcc	351,02
	hasta 1,5 m <sup>2</sup>	dms 1,1	actuador proporcional 24 V. Ac, mando señales 0-10 Vcc	422,44
		dms 1,1-s	actuador proporcional 24 V. Ac, mando señales 0-10 Vcc, con dos contactos auxiliares	505,39
		dms 2,2	actuador proporcional 220 V, mando gama Joventa	493,53
	hasta 3 m <sup>2</sup>	dm 1,1	actuador proporcional 24 v, mando señal 0-10 Vcc/4-20 mA	536,13
		dm 1,1-s	actuador proporcional 24 v, mando señal 0-10 Vcc/4-20 mA, con dos contactos auxiliares.	615,55
		dm 1,1-f-r	actuador proporcional 24 V, mando retorno 0-10 Vcc/4-20 mA	811,88
		dm 2,2	actuador proporcional 220V, mando gama Joventa	587,04
		pa	potenciómetro manual 0-100% para actuadores proporcionales	89,04
		pf	potenciómetro manual 0-100% para actuadores proporcionales para cuadros eléctricos	74,94

Acoplamientos	
tarifa acoplamientos	
Descripción	PVP
acoplamiento 90°	149,77
acoplamiento T	146,26
biela	23,69
varilla 8 Mm. (por metro lineal)	4,18
sector manual	28,36



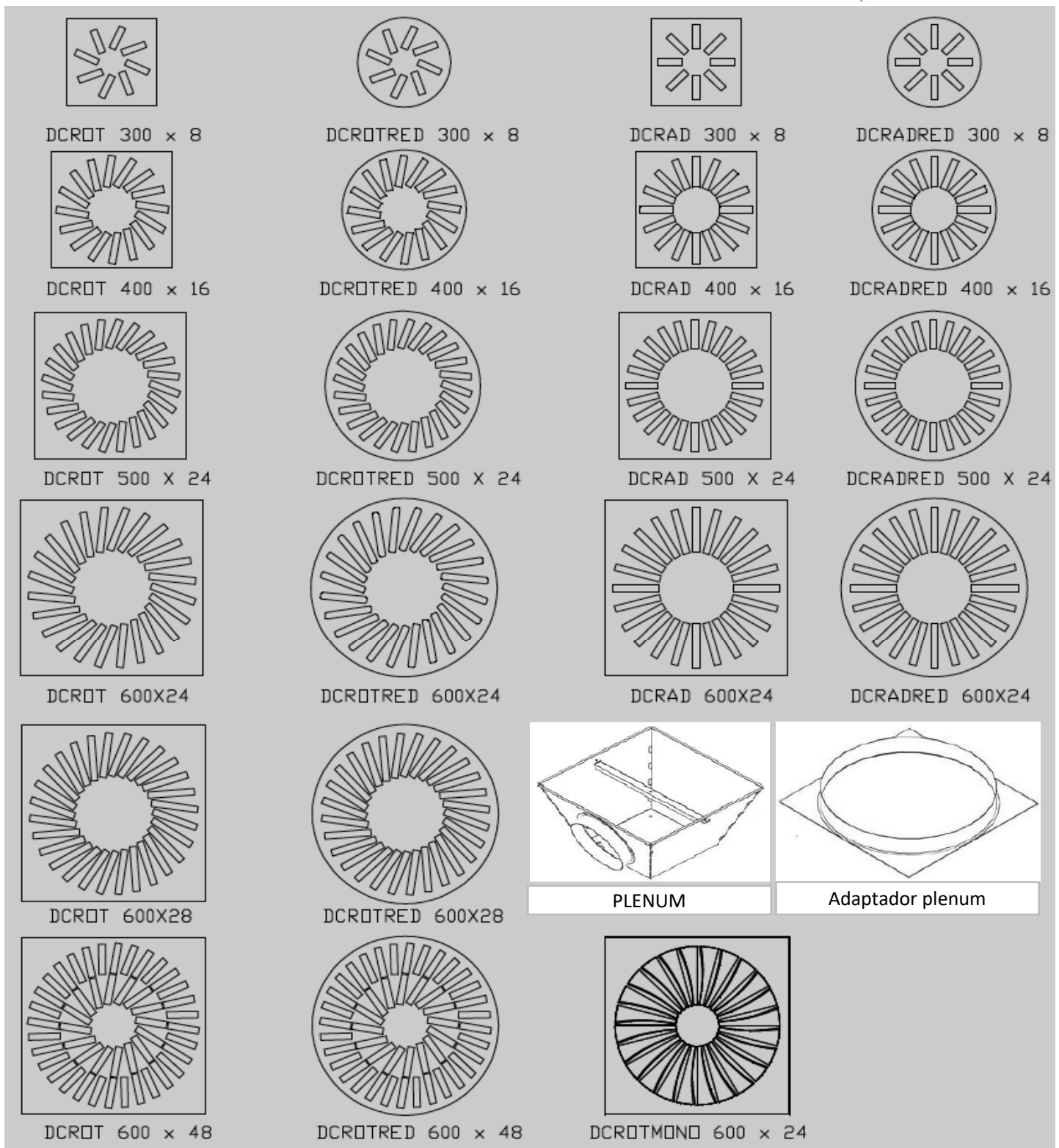

Modelo	Medidas	PVP
DCROT 300 X 8	294 X 294 mm	43,41
DCROT 400 X 16	394 X 394 mm	54,99
DCROT 500 X 24	494 x 494 mm	63,67
DCROT 600 X 24	594 X 594 mm	68,01
DCROT 600 X 28	594 X 594 mm	76,69
DCROT 600 X 48	594 x 594 mm	92,61
DCROTRED 300 X 8	∅ 300	69,46
DCROTRED 400 X 16	∅ 400	81,03
DCROTRED 500 X 24	∅ 500	89,72
DCROTRED 600 X 24	∅ 600	94,06
DCROTRED 600 X 28	∅ 600	102,74
DCROTRED 600 X 48	∅ 600	118,66

Modelo	Medidas	PVP
DCRAD 300 X 8	294 X 294 mm	43,41
DCRAD 400 X 16	394 X 394 mm	54,99
DCRAD 500 X 24	494 x 494 mm	63,67
DCRAD 600 X 24	594 X 594 mm	68,01
DCRADRED 300 X 8	∅ 300	69,46
DCRADRED 400 X 16	∅ 400	81,03
DCRADRED 500 X 24	∅ 500	89,72
DCRADRED 600 X 24	∅ 600	94,06
DCROT MONO 600X24	594 X 594	57,88

Modelo	Medidas	PVP
	∅ CUELLO	
PLENUM 300	125 mm	54,99
PLENUM 400	160 mm	69,46
PLENUM 500	200 mm	80,72
PLENUM 600	250 mm	99,36
Adaptador plenum ∅ 300		18,81
Adaptador plenum ∅ 400		23,15
Adaptador plenum ∅ 500		27,49
Adaptador plenum ∅ 600		31,83

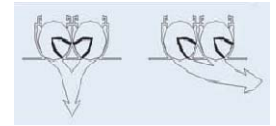

Impulsion

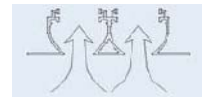

Retorno

**DL Difusor lineal**

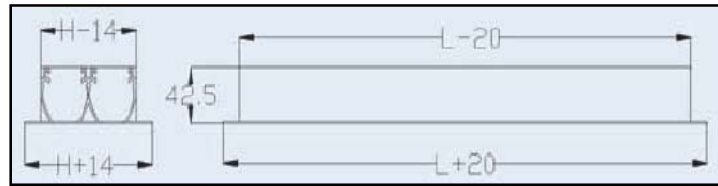

DL		L : longitud																
		500	600	700	800	900	1000	1100	1200	1300	1400	1500	1600	1700	1800	1900	2000	1 ml *
VIAS	1	34,51	38,17	41,41	44,99	45,48	51,86	55,31	58,89	62,44	66,01	69,20	72,26	76,22	79,67	83,41	86,33	43,16
	2	51,93	58,17	64,55	70,28	75,40	83,46	89,41	95,52	102,20	108,60	114,23	120,13	127,28	133,27	139,10	144,86	72,44
	3	69,24	78,21	87,17	96,57	105,37	114,26	122,97	131,81	142,04	149,38	158,74	168,26	176,84	186,07	194,99	205,06	102,52
	4	86,45	98,70	110,02	121,55	133,21	146,43	157,36	168,52	181,50	193,08	204,02	216,04	228,10	238,82	250,92	263,50	131,75

\* Precios por metro para difusores mayores de 2.000 mm

**DLP Difusor lineal con plenum**

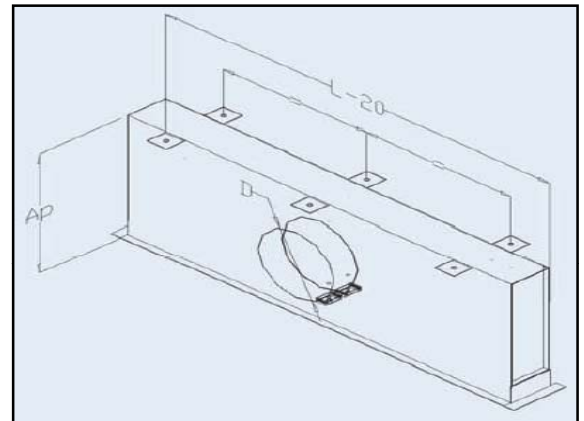

DLP		L : longitud																
		500	600	700	800	900	1000	1100	1200	1300	1400	1500	1600	1700	1800	1900	2000	1 ml *
VIAS	1	86,78	93,75	101,03	106,99	114,92	121,61	131,71	142,04	150,81	161,01	174,05	179,58	186,67	193,45	200,76	207,63	103,82
	2	105,43	115,85	129,10	140,48	152,66	165,40	177,07	188,75	201,89	213,78	225,04	238,50	248,93	261,33	274,57	285,11	142,55
	3	124,42	137,55	154,34	169,78	184,48	202,11	216,69	231,83	248,82	264,98	280,72	295,54	312,76	326,41	343,73	361,45	180,73
	4	143,40	158,31	180,50	202,22	221,70	243,51	263,52	282,61	304,41	324,11	349,57	366,06	387,72	409,84	429,67	452,59	226,29

\* Precios por metro para difusores mayores de 2.000 mm